

SMD Power Inductors

SLF Series

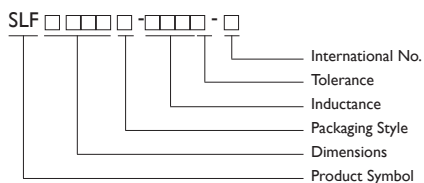

PRODUCT IDENTIFICATION



FEATURES

- Low resistance and high currents

Designed for low - profile type with low Rdc and large current.

The magnetic shielded type is suitable for high density mounting.

Flat bottom surface allows for reliable mounting onto the board.

Soldering conditions can be easily confirmed when mounting onto the board.

Provide with embossed carrier type packaging for automatic mounting machine.

APPLICATIONS

Portable telephones, computers, hard disk drives and

Other electronic equipment.

- Packaging: T : Tape and Reel
- Tolerance: M: $\pm 20\%$
- Note: YAGEO will start to release SLF Series inductors with lead-free terminals which meet SONY SS-00259's criteria for lead-free product in Q2 of 2004, and YAGEO Internal No will be changed to "N" as identification. Ex. SLF0628T-4R7M-N

SHAPES AND DIMENSIONS

Dimensions : mm

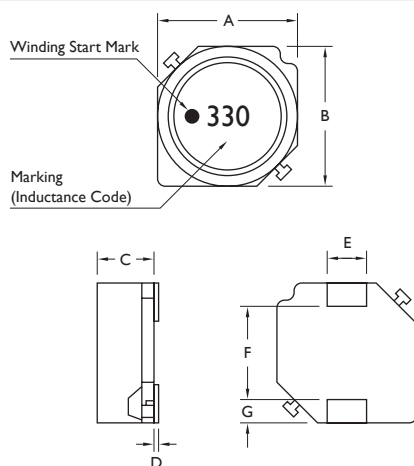

TYPE	A	B	C	D	E	F	G	WEIGHT
SLF0628	6 ± 0.2	6 ± 0.2	2.8 ± 0.2	0.05typ	2 typ	4.0 typ	0.9 typ	
SLF0728	7 ± 0.2	7 ± 0.2	2.8 ± 0.2	0.1typ	2 typ	4.9 typ	0.9 typ	
SLF0730	7 ± 0.2	7 ± 0.2	3.0 ± 0.2	0.1typ	2 typ	4.9 typ	0.9 typ	
SLF0732	7 ± 0.2	7 ± 0.2	3.2 ± 0.2	0.1typ	2 typ	4.9 typ	0.9 typ	
SLF0745	7 ± 0.2	7 ± 0.2	4.5 ± 0.3	0.1typ	2 typ	4.9 typ	0.9 typ	
SLF1045	10.1 ± 0.3	10.1 ± 0.3	4.5 ± 0.3	0.15typ	3 typ	6 typ	2 typ	
SLF1255	12.5 ± 0.3	12.5 ± 0.3	5.5 ± 0.3	0.1typ	3 typ	8.6 typ	2 typ	
SLF1265	12.5 ± 0.3	12.5 ± 0.3	6.5 ± 0.35	0.1typ	3 typ	8.6 typ	2 typ	
SLF1275	12.5 ± 0.3	12.5 ± 0.3	7.5 ± 0.35	0.1typ	3 typ	8.6 typ	2 typ	



ELECTRICAL CHARACTERISTICS SLF0628 SERIES

PART NO.	INDUCTANCE (μ H)	TOLERANCE (\pm %)	TEST FREQUENCY L(KHz)	DC RESISTANCE (Ω) \pm 20%	RATED CURRENT (A) Max.	ITEMP (A) Max.
SLF0628T-4R7M-S	4.7	20	1	0.0284	1.6	2.5
SLF0628T-6R8M-S	6.8	20	1	0.0354	1.5	2.2
SLF0628T-100M-S	10	20	1	0.0532	1.3	1.8
SLF0628T-150M-S	15	20	1	0.0745	1.0	1.4
SLF0628T-220M-S	22	20	1	0.104	0.77	1.3
SLF0628T-330M-S	33	20	1	0.148	0.69	1.1
SLF0628T-470M-S	47	20	1	0.21	0.59	0.92
SLF0628T-680M-S	68	20	1	0.29	0.50	0.78
SLF0628T-101M-S	100	20	1	0.43	0.42	0.64

IDC Current : Value obtained when DC current flows and the initial value of inductance has fallen by 30%.

Itemp Current : Value obtained when current flows and the temperature has risen to 25°C.

Test Equipment Inductance : HP4192A LF Impedance Analyzer or Equivalent (Test Frequency : 1KHz/0.5V)

RDC : SC-7401 Digital Multimeter ,or Equivalent

ELECTRICAL CHARACTERISTICS : LEAD-FREE & ROHS COMPLIANCE

PART NO.	INDUCTANCE (μ H)	TEST Frequency	RDC (Ω) \pm 20%	IDC (A)Max	ITEMP (A) Max.
SLF0628T-4R7□-N	4.7	0.5V 1KHZ	0.0284	1.6	2.5
SLF0628T-6R8□-N	6.8	0.5V 1KHZ	0.0354	1.5	2.2
SLF0628T-100□-N	10	0.5V 1KHZ	0.0532	1.3	1.8
SLF0628T-150□-N	15	0.5V 1KHZ	0.0745	1	1.4
SLF0628T-220□-N	22	0.5V 1KHZ	0.104	0.77	1.3
SLF0628T-330□-N	33	0.5V 1KHZ	0.148	0.69	1.1
SLF0628T-470□-N	47	0.5V 1KHZ	0.21	0.59	0.92
SLF0628T-680□-N	68	0.5V 1KHZ	0.29	0.5	0.78
SLF0628T-101□-N	100	0.5V 1KHZ	0.43	0.42	0.64

NOTE : □ -tolerance M= \pm 20%

1.IDC Current : Value obtained when DC current flows and the initial value of inductance has fallen by 30%.

2.Itemp Current : Value obtained when current flows and the temperature has risen to 25°C.

3.40°C rise typ.at Irms.

"-N"FOR COMPLETELY LEAD FREETYPE(INCLUDING FERRITE BODY & SOLDER)



ELECTRICAL CHARACTERISTICS SLF0728 SERIES

PART NO.	INDUCTANCE (μH)	TOLERANCE ($\pm\%$)	TEST FREQUENCY L(KHz)	DC RESISTANCE ($\Omega \pm 20\%$)	RATED CURRENT (A) Max.
SLF0728T-3R3M-S	3.3	20	1	0.037	1.6
SLF0728T-4R7M-S	4.7	20	1	0.045	1.5
SLF0728T-6R8M-S	6.8	20	1	0.059	1.3
SLF0728T-100M-S	10	20	1	0.083	1.1
SLF0728T-150M-S	15	20	1	0.13	0.88
SLF0728T-220M-S	22	20	1	0.18	0.75
SLF0728T-330M-S	33	20	1	0.24	0.65
SLF0728T-470M-S	47	20	1	0.34	0.54

IDC current : Value obtained when DC current flows and the initial value of inductance has fallen by 10%.

Test Equipment Inductance : HP4192A LF Impedance Analyzer or Equivalent (Test Frequency : 1KHz/0.5V)

RDC : SC-7401 Digital Multimeter ,or Equivalent

ELECTRICAL CHARACTERISTICS : LEAD-FREE & ROHS COMPLIANCE

PART NO.	INDUCTANCE (μH)	TEST Frequency	RDC ($\Omega \pm 20\%$)	RATED CURRENT (A)Max
SLF0728T-3R3 □ -N	3.3	0.5V 1KHZ	0.037	1.60
SLF0728T-4R7 □ -N	4.7	0.5V 1KHZ	0.045	1.50
SLF0728T-6R8 □ -N	6.8	0.5V 1KHZ	0.059	1.30
SLF0728T-100 □ -N	10	0.5V 1KHZ	0.083	1.10
SLF0728T-150 □ -N	15	0.5V 1KHZ	0.130	0.88
SLF0728T-220 □ -N	22	0.5V 1KHZ	0.180	0.75
SLF0728T-330 □ -N	33	0.5V 1KHZ	0.240	0.65
SLF0728T-470 □ -N	47	0.5V 1KHZ	0.340	0.54

NOTE : □ -tolerance M= $\pm 20\%$

1.IDC Current : Value obtained when DC current flows and the initial value of inductance has fallen by 30%.

2.Itemp Current : Value obtained when current flows and the temperature has risen to 25°C.

3.40°C rise typ.at Irms.

"-N"FOR COMPLETELY LEAD FREETYPE(INCLUDING FERRITE BODY & SOLDER)



ELECTRICAL CHARACTERISTICS SLF0730 SERIES

PART NO.	INDUCTANCE (μ H)	TOLERANCE (\pm %)	TEST FREQUENCY L(KHz)	DC RESISTANCE (Ω) \pm 20%	RATED CURRENT (A) Max.
SLF0730T-3R3M-S	3.3	20	1	0.023	1.8
SLF0730T-4R7M-S	4.7	20	1	0.036	1.6
SLF0730T-6R8M-S	6.8	20	1	0.041	1.5
SLF0730T-100M-S	10	20	1	0.053	1.3
SLF0730T-150M-S	15	20	1	0.084	1
SLF0730T-220M-S	22	20	1	0.11	0.86
SLF0730T-330M-S	33	20	1	0.16	0.65
SLF0730T-470M-S	47	20	1	0.24	0.57
SLF0730T-680M-S	68	20	1	0.31	0.49
SLF0730T-101M-S	100	20	1	0.45	0.35

IDC Current : Value obtained when DC current flows and the initial value of inductance has fallen by 10%.

Test Equipment Inductance : HP4192A LF Impedance Analyzer or Equivalent (Test Frequency : 1KHz/0.5V)

RDC : SC-7401 Digital Multimeter ,or Equivalent

ELECTRICAL CHARACTERISTICS : LEAD-FREE & ROHS COMPLIANCE

PART NO.	INDUCTANCE (μ H)	TEST Frequency	RDC (Ω) \pm 20%	RATED CURRENT (A)Max
SLF0730T-3R3 □ -N	3.3	0.5V 1KHZ	0.023	1.8
SLF0730T-4R7 □ -N	4.7	0.5V 1KHZ	0.036	1.6
SLF0730T-6R8 □ -N	6.8	0.5V 1KHZ	0.041	1.5
SLF0730T-100 □ -N	10	0.5V 1KHZ	0.053	1.3
SLF0730T-150 □ -N	15	0.5V 1KHZ	0.084	1.0
SLF0730T-220 □ -N	22	0.5V 1KHZ	0.11	0.86
SLF0730T-330 □ -N	33	0.5V 1KHZ	0.16	0.65
SLF0730T-470 □ -N	47	0.5V 1KHZ	0.24	0.57
SLF0730T-680 □ -N	68	0.5V 1KHZ	0.31	0.49
SLF0730T-101 □ -N	100	0.5V 1KHZ	0.45	0.35

NOTE : □ -tolerance M= \pm 20%

1.IDC Current : Value obtained when DC current flows and the initial value of inductance has fallen by 30%.

2.Itemp Current : Value obtained when current flows and the temperature has risen to 25°C.

3.40°C rise typ.at Irms.

"-N"FOR COMPLETELY LEAD FREETYPE(INCLUDING FERRITE BODY & SOLDER)



ELECTRICAL CHARACTERISTICS SLF0732 SERIES

PART NO.	INDUCTANCE (μ H)	TOLERANCE (\pm %)	TEST FREQUENCY L(KHz)	DC RESISTANCE (Ω) \pm 20%	RATED CURRENT (A) Max.
SLF0732T-3R3M-S	3.3	20	1	0.023	1.9
SLF0732T-4R7M-S	4.7	20	1	0.036	1.7
SLF0732T-6R8M-S	6.8	20	1	0.041	1.6
SLF0732T-100M-S	10	20	1	0.053	1.4
SLF0732T-150M-S	15	20	1	0.075	1.1
SLF0732T-220M-S	22	20	1	0.11	0.96
SLF0732T-330M-S	33	20	1	0.16	0.75
SLF0732T-470M-S	47	20	1	0.24	0.67
SLF0732T-680M-S	68	20	1	0.31	0.59
SLF0732T-101M-S	100	20	1	0.45	0.45
SLF0732T-151M-S	150	20	1	0.65	0.37
SLF0732T-221M-S	220	20	1	1.05	0.29
SLF0732T-331M-S	330	20	1	1.67	0.22
SLF0732T-471M-S	470	20	1	2.05	0.2
SLF0732T-681M-S	680	20	1	3.15	0.16
SLF0732T-102M-S	1000	20	1	4.78	0.13

IDC current : Value obtained when DC current flows and the initial value of inductance has fallen by 10%.

Test Equipment Inductance : HP4192A LF Impedance Analyzer or Equivalent (Test Frequency : 1KHz/0.5V)

RDC : SC-7401 Digital Multimeter ,or Equivalent

ELECTRICAL CHARACTERISTICS : LEAD-FREE & ROHS COMPLIANCE

PART NO.	INDUCTANCE (μ H)	TEST Frequency	RDC (Ω) \pm 20%	RATED CURRENT (A)Max
SLF0732T-2R2 <input type="checkbox"/> -N	2.2	0.5V 1KHZ	0.018	2.1
SLF0732T-3R3 <input type="checkbox"/> -N	3.3	0.5V 1KHZ	0.023	1.9
SLF0732T-4R7 <input type="checkbox"/> -N	4.7	0.5V 1KHZ	0.036	1.7
SLF0732T-6R8 <input type="checkbox"/> -N	6.8	0.5V 1KHZ	0.041	1.6
SLF0732T-100 <input type="checkbox"/> -N	10	0.5V 1KHZ	0.053	1.4
SLF0732T-150 <input type="checkbox"/> -N	15	0.5V 1KHZ	0.075	1.1
SLF0732T-220 <input type="checkbox"/> -N	22	0.5V 1KHZ	0.11	0.96
SLF0732T-330 <input type="checkbox"/> -N	33	0.5V 1KHZ	0.16	0.75
SLF0732T-470 <input type="checkbox"/> -N	47	0.5V 1KHZ	0.24	0.67
SLF0732T-680 <input type="checkbox"/> -N	68	0.5V 1KHZ	0.31	0.59
SLF0732T-101 <input type="checkbox"/> -N	100	0.5V 1KHZ	0.45	0.45
SLF0732T-151 <input type="checkbox"/> -N	150	0.5V 1KHZ	0.65	0.37
SLF0732T-221 <input type="checkbox"/> -N	220	0.5V 1KHZ	1.05	0.29
SLF0732T-331 <input type="checkbox"/> -N	330	0.5V 1KHZ	1.67	0.22
SLF0732T-471 <input type="checkbox"/> -N	470	0.5V 1KHZ	2.05	0.2
SLF0732T-681 <input type="checkbox"/> -N	680	0.5V 1KHZ	3.15	0.16
SLF0732T-102 <input type="checkbox"/> -N	1000	0.5V 1KHZ	4.78	0.13

NOTE : -tolerance M= \pm 20%

1.IDC Current : Value obtained when DC current flows and the initial value of inductance has fallen by 30%.

2.Itemp Current : Value obtained when current flows and the temperature has risen to 25°C.

3.40°C rise typ.at Irms.

"-N"FOR COMPLETELY LEAD FREE TYPE(INCLUDING FERRITE BODY & SOLDER)



ELECTRICAL CHARACTERISTICS SLF0745 SERIES

PART NO.	INDUCTANCE (μ H)	TOLERANCE ($\pm\%$)	TEST FREQUENCY L(KHz)	DC RESISTANCE (Ω) \pm 20%	RATED CURRENT (A) Max.	ITEMP (A) Max.
SLF0745T-3R3M-S	3.3	20	1	0.02	2.5	2.3
SLF0745T-4R7M-S	4.7	20	1	0.03	2	2.1
SLF0745T-6R8M-S	6.8	20	1	0.039	1.7	1.74
SLF0745T-100M-S	10	20	1	0.036	1.3	1.78
SLF0745T-150M-S	15	20	1	0.052	1.1	1.53
SLF0745T-220M-S	22	20	1	0.061	0.9	1.34
SLF0745T-330M-S	33	20	1	0.096	0.82	1.09
SLF0745T-470M-S	47	20	1	0.125	0.75	0.92
SLF0745T-680M-S	68	20	1	0.175	0.6	0.77
SLF0745T-101M-S	100	20	1	0.25	0.5	0.65
SLF0745T-151M-S	150	20	1	0.34	0.4	0.55
SLF0745T-221M-S	220	20	1	0.52	0.33	0.45
SLF0745T-331M-S	330	20	1	0.74	0.25	0.37
SLF0745T-471M-S	470	20	1	1.05	0.22	0.31
SLF0745T-681M-S	680	20	1	1.48	0.2	0.27
SLF0745T-102M-S	1000	20	1	2.28	0.14	0.25

IDC current : Value obtained when DC current flows and the initial value of inductance has fallen by 10%.

Itemp current : Value obtained when current flows and the temperature has risen to 20°C.

Test Equipment Inductance : HP4192A LF Impedance Analyzer or Equivalent (Test Frequency : 1KHz/0.5V)

RDC : SC-7401 Digital Multimeter ,or Equivalent

ELECTRICAL CHARACTERISTICS : LEAD-FREE & ROHS COMPLIANCE

PART NO.	INDUCTANCE (μ H)	TEST Frequency	RDC (Ω) \pm 20%	IDC (A)Max	ITEMP (A) Max.
SLF0745T-3R3 □ -N	3.3	0.5V 1KHZ	0.02	2.5	2.3
SLF0745T-4R7 □ -N	4.7	0.5V 1KHZ	0.03	2	2.1
SLF0745T-6R8 □ -N	6.8	0.5V 1KHZ	0.039	1.7	1.74
SLF0745T-100 □ -N	10	0.5V 1KHZ	0.036	1.3	1.78
SLF0745T-150 □ -N	15	0.5V 1KHZ	0.052	1.1	1.53
SLF0745T-220 □ -N	22	0.5V 1KHZ	0.061	0.9	1.34
SLF0745T-330 □ -N	33	0.5V 1KHZ	0.096	0.82	1.09
SLF0745T-470 □ -N	47	0.5V 1KHZ	0.125	0.75	0.92
SLF0745T-680 □ -N	68	0.5V 1KHZ	0.175	0.6	0.77
SLF0745T-101 □ -N	100	0.5V 1KHZ	0.25	0.5	0.65
SLF0745T-151 □ -N	150	0.5V 1KHZ	0.34	0.4	0.55
SLF0745T-221 □ -N	220	0.5V 1KHZ	0.52	0.33	0.45
SLF0745T-331 □ -N	330	0.5V 1KHZ	0.74	0.25	0.37
SLF0745T-471 □ -N	470	0.5V 1KHZ	1.05	0.22	0.31
SLF0745T-681 □ -N	680	0.5V 1KHZ	1.48	0.2	0.27
SLF0745T-102 □ -N	1000	0.5V 1KHZ	2.28	0.14	0.25

NOTE : □ -tolerance M= \pm 20%

1.IDC Current : Value obtained when DC current flows and the initial value of inductance has fallen by 30%.

2.Itemp Current : Value obtained when current flows and the temperature has risen to 25°C.

3.40°C rise typ.at Irms.

"-N"FOR COMPLETELY LEAD FREETYPE(INCLUDING FERRITE BODY & SOLDER)



ELECTRICAL CHARACTERISTICS SLF1045 SERIES

PART NO.	INDUCTANCE (μ H)	TOLERANCE (\pm %)	TEST FREQUENCY L(KHz)	DC RESISTANCE (Ω) \pm 20%	RATED CURRENT (A) Max.	ITEMP (A) Max.
SLF1045T-100M-S	10	20	1	0.0364	3	2.5
SLF1045T-150M-S	15	20	1	0.0472	2.4	2.2
SLF1045T-220M-S	22	20	1	0.0591	2.1	1.9
SLF1045T-330M-S	33	20	1	0.0815	1.6	1.7
SLF1045T-470M-S	47	20	1	0.1	1.4	1.5
SLF1045T-680M-S	68	20	1	0.14	1.2	1.3
SLF1045T-101M-S	100	20	1	0.2	1	1.1
SLF1045T-151M-S	150	20	1	0.35	0.79	0.81
SLF1045T-221M-S	220	20	1	0.47	0.65	0.7
SLF1045T-331M-S	330	20	1	0.68	0.54	0.58
SLF1045T-471M-S	470	20	1	1.03	0.47	0.47
SLF1045T-681M-S	680	20	1	1.6	0.38	0.38
SLF1045T-102M-S	1000	20	1	2.8	0.32	0.29
SLF1045T-152M-S	1500	20	1	3.4	0.22	0.26

IDC current : Value obtained when DC current flows and the initial value of inductance has fallen by 10%.

Itemp current : Value obtained when current flows and the temperature has risen to 30°C.

Test Equipment Inductance : HP4192A LF Impedance Analyzer or Equivalent (Test Frequency : 1KHz/0.5V)

RDC : SC-7401 Digital Multimeter ,or Equivalent

ELECTRICAL CHARACTERISTICS : LEAD-FREE & ROHS COMPLIANCE

PART NO.	INDUCTANCE (μ H)	TEST Frequency	RDC (Ω) \pm 20%	IDC (A)Max	ITEMP (A) Max.
SLF1045T-100 □ -N	10	0.5V 1KHZ	0.0364	3	2.5
SLF1045T-150 □ -N	15	0.5V 1KHZ	0.0472	2.4	2.2
SLF1045T-220 □ -N	22	0.5V 1KHZ	0.0591	2.1	1.9
SLF1045T-330 □ -N	33	0.5V 1KHZ	0.0815	1.6	1.7
SLF1045T-470 □ -N	47	0.5V 1KHZ	0.1	1.4	1.5
SLF1045T-680 □ -N	68	0.5V 1KHZ	0.14	1.2	1.3
SLF1045T-101 □ -N	100	0.5V 1KHZ	0.2	1	1.1
SLF1045T-151 □ -N	150	0.5V 1KHZ	0.35	0.79	0.81
SLF1045T-221 □ -N	220	0.5V 1KHZ	0.47	0.65	0.7
SLF1045T-331 □ -N	330	0.5V 1KHZ	0.68	0.54	0.58
SLF1045T-471 □ -N	470	0.5V 1KHZ	1.03	0.47	0.47
SLF1045T-681 □ -N	680	0.5V 1KHZ	1.6	0.38	0.38
SLF1045T-102 □ -N	1000	0.5V 1KHZ	2.8	0.32	0.29
SLF1045T-152 □ -N	1500	0.5V 1KHZ	3.4	0.22	0.26

NOTE : □ -tolerance M= \pm 20%

1.IDC Current : Value obtained when DC current flows and the initial value of inductance has fallen by 30%.

2.Itemp Current : Value obtained when current flows and the temperature has risen to 25°C.

3.40°C rise typ.at Irms.

"-N"FOR COMPLETELY LEAD FREE TYPE(INCLUDING FERRITE BODY & SOLDER)



ELECTRICAL CHARACTERISTICS SLFI255 SERIES

PART NO.	INDUCTANCE (μ H)	TOLERANCE (\pm %)	TEST FREQUENCY (KHz)	DC RESISTANCE (Ω) \pm 20%	RATED CURRENT (A) Max.	ITEMP (A) Max.
SLFI255T-6R0M-S	6	20	1	0.0164	3.6	4.9
SLFI255T-100M-S	10	20	1	0.0215	3.4	4.3
SLFI255T-150M-S	15	20	1	0.0259	2.8	3.9
SLFI255T-220M-S	22	20	1	0.0338	2.3	3.4
SLFI255T-330M-S	33	20	1	0.0415	1.9	3.1
SLFI255T-470M-S	47	20	1	0.0618	1.6	2.5
SLFI255T-680M-S	68	20	1	0.0832	1.3	2.2
SLFI255T-101M-S	100	20	1	0.117	1.1	1.8
SLFI255T-151M-S	150	20	1	0.19	0.88	1.4
SLFI255T-221M-S	220	20	1	0.27	0.72	1.2
SLFI255T-331M-S	330	20	1	0.41	0.59	1
SLFI255T-471M-S	470	20	1	0.52	0.49	0.88
SLFI255T-681M-S	680	20	1	0.76	0.43	0.73
SLFI255T-102M-S	1000	20	1	1.12	0.34	0.6
SLFI255T-152M-S	1500	20	1	1.73	0.29	0.48

IDC current : Value obtained when DC current flows and the initial value of inductance has fallen by 10%.

Itemp current : Value obtained when current flows and the temperature has risen to 30°C.

Test Equipment Inductance : HP4192A LF Impedance Analyzer or Equivalent (Test Frequency : 1KHz/0.5V)

RDC : SC-7401 Digital Multimeter ,or Equivalent

ELECTRICAL CHARACTERISTICS : LEAD-FREE & ROHS COMPLIANCE

PART NO.	INDUCTANCE (μ H)	TEST Frequency	RDC (Ω) \pm 20%	IDC (A)Max	ITEMP (A) Max.
SLFI255T-6R0 <input type="checkbox"/> -N	6	0.5V 1KHZ	0.0164	3.6	4.9
SLFI255T-100 <input type="checkbox"/> -N	10	0.5V 1KHZ	0.0215	3.4	4.3
SLFI255T-150 <input type="checkbox"/> -N	15	0.5V 1KHZ	0.0259	2.8	3.9
SLFI255T-220 <input type="checkbox"/> -N	22	0.5V 1KHZ	0.0338	2.3	3.4
SLFI255T-330 <input type="checkbox"/> -N	33	0.5V 1KHZ	0.0415	1.9	3.1
SLFI255T-470 <input type="checkbox"/> -N	47	0.5V 1KHZ	0.0618	1.6	2.5
SLFI255T-680 <input type="checkbox"/> -N	68	0.5V 1KHZ	0.0832	1.3	2.2
SLFI255T-101 <input type="checkbox"/> -N	100	0.5V 1KHZ	0.117	1.1	1.8
SLFI255T-151 <input type="checkbox"/> -N	150	0.5V 1KHZ	0.19	0.88	1.4
SLFI255T-221 <input type="checkbox"/> -N	220	0.5V 1KHZ	0.27	0.72	1.2
SLFI255T-331 <input type="checkbox"/> -N	330	0.5V 1KHZ	0.41	0.59	1
SLFI255T-471 <input type="checkbox"/> -N	470	0.5V 1KHZ	0.52	0.49	0.88
SLFI255T-681 <input type="checkbox"/> -N	680	0.5V 1KHZ	0.76	0.43	0.73
SLFI255T-102 <input type="checkbox"/> -N	1000	0.5V 1KHZ	1.12	0.34	0.6
SLFI255T-152 <input type="checkbox"/> -N	1500	0.5V 1KHZ	1.73	0.29	0.48

NOTE : -tolerance M= \pm 20%

1.IDC Current : Value obtained when DC current flows and the initial value of inductance has fallen by 30%.

2.Itemp Current : Value obtained when current flows and the temperature has risen to 25°C.

3.40°C rise typ.at Irms.

"-N"FOR COMPLETELY LEAD FREETYPE(INCLUDING FERRITE BODY & SOLDER)



ELECTRICAL CHARACTERISTICS SLF1265 SERIES

PART NO.	INDUCTANCE (μ H)	TOLERANCE (\pm %)	TEST FREQUENCY (KHz)	DC RESISTANCE (Ω) \pm 20%	RATED CURRENT (A) Max.	ITEMP (A) Max.
SLF1265T-2R0M-S	2	30	1	0.0117	10	6.2
SLF1265T-4R2M-S	4.2	30	1	0.015	7.3	5.5
SLF1265T-7R0M-S	7	30	1	0.0177	5.7	5
SLF1265T-100M-S	10	20	1	0.0202	5	4.8
SLF1265T-150M-S	15	20	1	0.0237	4.2	4.4
SLF1265T-220M-S	22	20	1	0.0316	3.5	3.8
SLF1265T-330M-S	33	20	1	0.0406	2.8	3.4
SLF1265T-470M-S	47	20	1	0.0578	2.4	2.8
SLF1265T-680M-S	68	20	1	0.0787	2	2.4
SLF1265T-101M-S	100	20	1	0.123	1.6	1.9
SLF1265T-221M-S	220	20	1	0.273	1	1.2

IDC current : Value obtained when DC current flows and the initial value of inductance has fallen by 10%.

Itemp current : Value obtained when current flows and the temperature has risen to 40°C.

Test equipment Inductance : HP4192A LF Impedance Analyzer or Equivalent (Test Frequency : 1KHz/0.5V)

RDC : SC-7401 Digital Multimeter ,or Equivalent

ELECTRICAL CHARACTERISTICS : LEAD-FREE & ROHS COMPLIANCE

PART NO.	INDUCTANCE (μ H)	TEST Frequency	RDC (Ω) \pm 20%	IDC (A)Max	ITEMP (A) Max.
SLF1265T-2R0 □ -N	2	0.5V 1KHZ	0.0117	10	6.2
SLF1265T-4R2 □ -N	4.2	0.5V 1KHZ	0.015	7.3	5.5
SLF1265T-7R0 □ -N	7	0.5V 1KHZ	0.0177	5.7	5
SLF1265T-100 □ -N	10	0.5V 1KHZ	0.0202	5	4.8
SLF1265T-150 □ -N	15	0.5V 1KHZ	0.0237	4.2	4.4
SLF1265T-220 □ -N	22	0.5V 1KHZ	0.0316	3.5	3.8
SLF1265T-330 □ -N	33	0.5V 1KHZ	0.0406	2.8	3.4
SLF1265T-470 □ -N	47	0.5V 1KHZ	0.0578	2.4	2.8
SLF1265T-680 □ -N	68	0.5V 1KHZ	0.0787	2	2.4
SLF1265T-101 □ -N	100	0.5V 1KHZ	0.123	1.6	1.9
SLF1265T-221 □ -N	220	0.5V 1KHZ	0.273	1	1.2

NOTE : □ -tolerance M= \pm 20%

1.IDC Current : Value obtained when DC current flows and the initial value of inductance has fallen by 30%.

2.Itemp Current : Value obtained when current flows and the temperature has risen to 25°C.

3.40°C rise typ.at Irms.

"-N"FOR COMPLETELY LEAD FREETYPE(INCLUDING FERRITE BODY & SOLDER)



ELECTRICAL CHARACTERISTICS SLF1275 SERIES

PART NO.	INDUCTANCE (μ H)	TOLERANCE (\pm %)	TEST FREQUENCY (KHz)	DC RESISTANCE (Ω) \pm 20%	RATED CURRENT (A) Max.	ITEMP (A) Max.
SLF1275T-1R2M-S	1.2	30	1	0.0069	13	8.2
SLF1275T-2R7M-S	2.7	30	1	0.0094	10	7
SLF1275T-3R9M-S	3.9	30	1	0.0104	9	6.7
SLF1275T-5R6M-S	5.6	30	1	0.0116	7.8	6.3
SLF1275T-6R8M-S	6.8	30	1	0.0131	7.2	5.9
SLF1275T-100M-S	10	20	1	0.0156	5.5	5.4
SLF1275T-150M-S	15	20	1	0.0184	4.7	5
SLF1275T-220M-S	22	20	1	0.0263	4	4
SLF1275T-330M-S	33	20	1	0.0395	3.2	3.4
SLF1275T-470M-S	47	20	1	0.0528	2.7	3
SLF1275T-680M-S	68	20	1	0.0778	2	2.4
SLF1275T-101M-S	100	20	1	0.125	1.9	1.9
SLF1275T-151M-S	150	20	1	0.175	1.5	1.6
SLF1275T-221M-S	220	20	1	0.258	1.3	1.3

IDC Current : Value obtained when DC current flows and the initial value of inductance has fallen by 10%.

Itemp Current : Value obtained when current flows and the temperature has risen to 40°C.

Test Equipment Inductance : HP4192A LF Impedance Analyzer or Equivalent (Test Frequency : 1KHz/0.5V)

RDC : SC-7401 Digital Multimeter ,or Equivalent

ELECTRICAL CHARACTERISTICS : LEAD-FREE & ROHS COMPLIANCE

PART NO.	INDUCTANCE (μ H)	TEST Frequency	RDC (Ω) \pm 20%	IDC (A)Max	ITEMP (A) Max.
SLF1275T-1R2T-N	1.2	0.5V 1KHZ	0.0069	13	8.2
SLF1275T-2R7T-N	2.7	0.5V 1KHZ	0.0094	10	7
SLF1275T-3R9T-N	3.9	0.5V 1KHZ	0.0104	9	6.7
SLF1275T-5R6T-N	5.6	0.5V 1KHZ	0.0116	7.8	6.3
SLF1275T-6R8T-N	6.8	0.5V 1KHZ	0.0131	7.2	5.9
SLF1275T-100 <input type="checkbox"/> -N	10	0.5V 1KHZ	0.0156	5.5	5.4
SLF1275T-150 <input type="checkbox"/> -N	15	0.5V 1KHZ	0.0184	4.7	5
SLF1275T-220 <input type="checkbox"/> -N	22	0.5V 1KHZ	0.0263	4	4
SLF1275T-330 <input type="checkbox"/> -N	33	0.5V 1KHZ	0.0395	3.2	3.4
SLF1275T-470 <input type="checkbox"/> -N	47	0.5V 1KHZ	0.0528	2.7	3
SLF1275T-680 <input type="checkbox"/> -N	68	0.5V 1KHZ	0.0778	2	2.4
SLF1275T-101 <input type="checkbox"/> -N	100	0.5V 1KHZ	0.125	1.9	1.9
SLF1275T-151 <input type="checkbox"/> -N	150	0.5V 1KHZ	0.175	1.5	1.6
SLF1275T-221 <input type="checkbox"/> -N	220	0.5V 1KHZ	0.258	1.3	1.3

NOTE : -tolerance M= \pm 20% / T= \pm 30%

1.IDC Current : Value obtained when DC current flows and the initial value of inductance has fallen by 30%.

2.Itemp Current : Value obtained when current flows and the temperature has risen to 25°C.

3.40°C rise typ.at Irms.

"-N"FOR COMPLETELY LEAD FREETYPE(INCLUDING FERRITE BODY & SOLDER)



TAPE DIMENSIONS

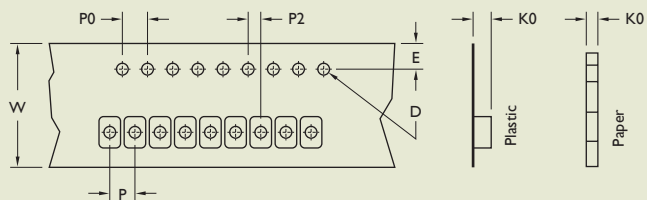

TAPE MATERIAL

Camer Tape : Polystyrene

Cover Type : Polyethylene

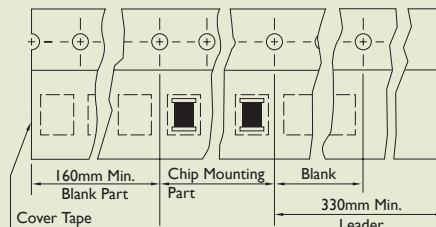

REEL DIMENSIONS

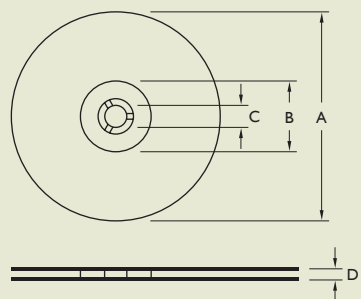

RECOMMENDED PATTERN

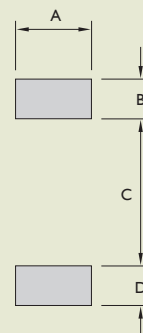

Dimensions : mm

TYPE	TAPE DIMENSIONS							RECOMMENDED PATTERN				REEL DIMENSIONS				QUANTITY PCS/REEL
	K0	D	E	W	P	P0	P2	A	B	C	D	A	B	C	D	
SLF0628	3.5	1.55	1.75	16	12	4	2	2.2	1.5	4	1.5	330	100	13	17.4	1000
SLF0728	3.5	1.55	1.75	16	12	4	2	2.2	1.5	4.9	1.5	330	100	13	17.4	1000
SLF0730	3.7	1.55	1.75	16	12	4	2	2.2	1.5	4.9	1.5	330	100	13	17.4	1000
SLF0732	4	1.55	1.75	16	12	4	2	2.2	1.5	4.9	1.5	330	100	13	17.4	1000
SLF0745	5.5	1.55	1.75	16	12	4	2	2.2	1.5	4.9	1.5	330	100	13	17.4	1000
SLF1045	5.5	1.55	1.75	24	24	4	2	3.2	2.5	5.6	2.5	330	100	13	24.4	500
SLF1255	6.5	1.55	1.75	24	24	4	2	3.2	2.5	8.6	2.5	330	100	13	24.4	500
SLF1265	7.5	1.55	1.75	24	24	4	2	3.2	2.5	8.6	2.5	330	100	13	24.4	500
SLF1275	8.5	1.55	1.75	24	24	4	2	3.2	2.5	8.6	2.5	330	100	13	24.4	500



SLF SERIES RELIABILITY TEST

I-1 MECHANICAL PERFORMANCE

NO.	ITEM	SPECIFICATION	TEST CONDITIONS
I-1-1	Vibration	Appearance : No Damage L Change : within $\pm 10\%$ Q Change : within $\pm 30\%$ RDC : within Specification	Test device shall be soldered on the substrate. Oscillation Frequency : 10 to 55 to 10Hz for 1Min. Amplitude : 1.5mm Time : 2Hrs. for each Axis (X,Y & Z), Total 6Hrs.
I-1-2	Resistance to Soldering Heat	Appearance : No Damage	Pre-heating : 150°C, 1Min. Solder Composition : Sn/Pb = 63/37 Solder Temperature : 260 \pm 5°C Immersion Time : 10 \pm 1Sec.
I-1-3	Solderability	The electrodes shall be at least 90% covered with new solder coating.	Pre-heating : 150°C, 1Min. Solder Composition : Sn/Pb = 63/37 Solder Temperature : 230 \pm 5°C Immersion Time : 4 \pm 1Sec.

I-2 ENVIRONMENTAL PERFORMANCE

NO.	ITEM	SPECIFICATION	TEST CONDITIONS															
I-2-1	Temperature Shock	Appearance : No Damage L Change : within $\pm 10\%$ L Change : within $\pm 30\%$ RDC : within Specification	10 Cycles (Air to Air) Cycles shall Consist of : 30Min. Exposure to -55°C 30Min. Exposure to 125°C 15Sec. Max. Transition between Temperatures Measured after Exposure in the Room Condition for 24Hrs.															
I-2-2	Temperature Cycle		One Cycle <table border="1"> <thead> <tr> <th>Step</th> <th>Temperature (°C)</th> <th>Time (Min.)</th> </tr> </thead> <tbody> <tr> <td>1</td> <td>-25 \pm 3</td> <td>30</td> </tr> <tr> <td>2</td> <td>25 \pm 2</td> <td>3</td> </tr> <tr> <td>3</td> <td>85 \pm 3</td> <td>30</td> </tr> <tr> <td>4</td> <td>25 \pm 2</td> <td>3</td> </tr> </tbody> </table> Total : 100 Cycles Measured after Exposure in the Room Condition for 24Hrs.	Step	Temperature (°C)	Time (Min.)	1	-25 \pm 3	30	2	25 \pm 2	3	3	85 \pm 3	30	4	25 \pm 2	3
Step	Temperature (°C)	Time (Min.)																
1	-25 \pm 3	30																
2	25 \pm 2	3																
3	85 \pm 3	30																
4	25 \pm 2	3																
I-2-3	Humidity Resistance		Temperature : 40 \pm 2°C Relative Humidity : 90 ~ 95% Time : 1000Hrs. Measured after Exposure in the Room Condition for 24Hrs.															
I-2-4	High Temperature Resistance		Temperature : 85 \pm 3°C Relative Humidity : 20% Applied Current : Rated Current Time : 1000Hrs. Measured after Exposure in the Room Condition for 24Hrs.															
I-2-5	Low Temperature Resistance		Temperature : -25 \pm 3°C Relative Humidity : 0% Time : 1000Hrs. Measured after Exposure in the Room Condition for 24Hrs.															



RECOMMEND SOLDERING CONDITIONS

for: CL/ CLH/ SQV/ SMD power inductors/ SMD Chip Beads/ SMD Filters, Transformers, Current Sensors

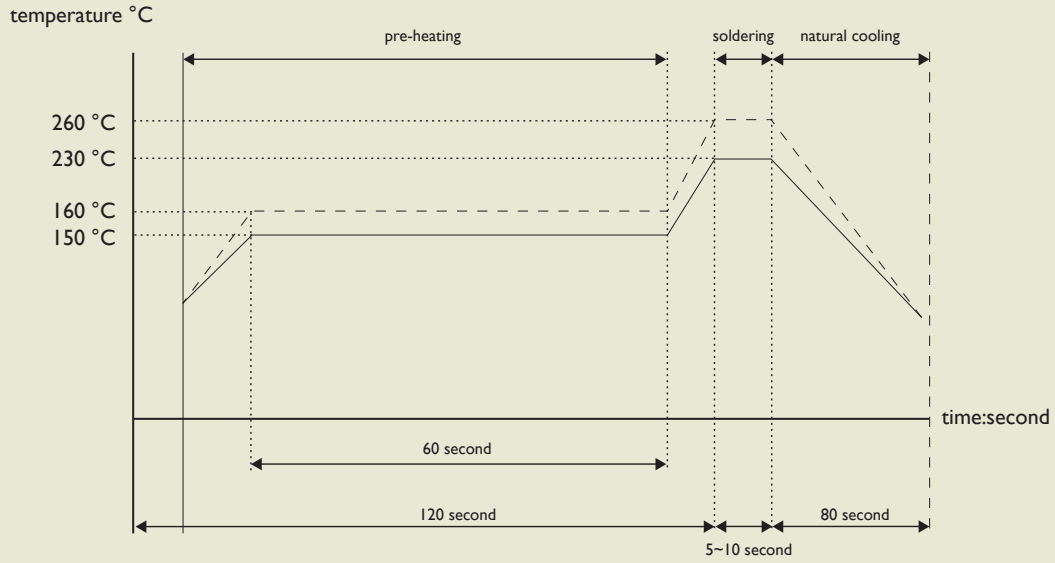

for: lead solder	—————
for: lead-free solder

SLF 1055 Series

Low Profile Low Power
Low & high Current

For SSL series provide excellent current carrying capabilities in a small footprint. They have a flat top for reliable pick and place operations and features robust temperature deflection. In addition to the standard versions shown here, custom inductors are available to meet your exact requirement.

APPLICATIONS

Portable telephones, computers, hard disk drives and other electronic equipment
Operating Temperature: -20°C~85°C

FEATURES

Low resistance and high currents

- Packaging: T : Tape and Reel
- Tolerance : M : ±20%
- Note: YAGEO has released lead-free products of SLF Series and Internal No. will be changed to "N" as identification. Ex. SLFI055T-100M-N



PRODUCT IDENTIFICATION

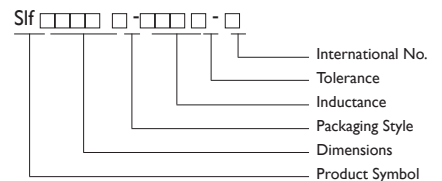

SHAPES AND DIMENSIONS

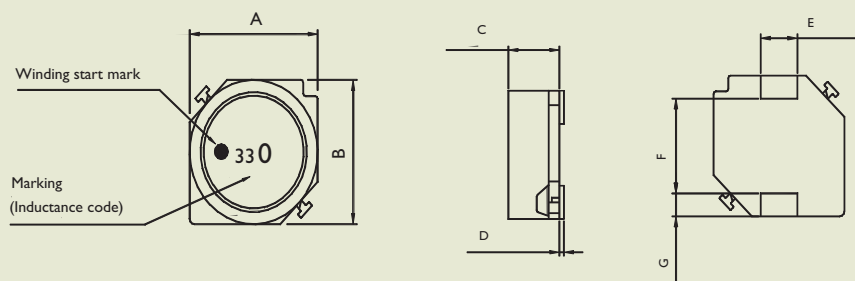

Dimensions : mm

A	B	C	D	E	F	G
10.1±0.3	10.1±0.3	5.5±0.3	0.15TYP	3TYP	6.0TYP	2.0TYP

RECOMMENDED PATTERN

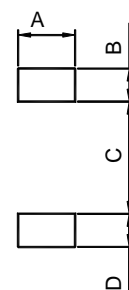

Dimensions : mm

A	B	C	D
3.2	2.5	5.6	2.5



ELECTRICAL CHARACTERISTICS

PART NO.	INDUCTANCE (μH)	TOLERANCE ($\pm\%$)	TEST FREQUENCY I(KHz)	DC RESISTANCE (Ω) $\pm 20\%$	RATED CURRENT (A) Max.
SLFI055T-100M-S	10	20	I	40	3.5
SLFI055T-330M-S	33	20	I	85	2.1

- Rated current: Value obtained when DC current flows and the initial value of inductance has by 15%
- Test equipment Inductance: HP4192A LF impedance analyzer or equivalent (Test frequency: 1KHz/0.5V)
- RDC: CH502BC Digital multimeter, or equivalent.

PACKAGING SPECIFICATIONS

Tape Dimensions

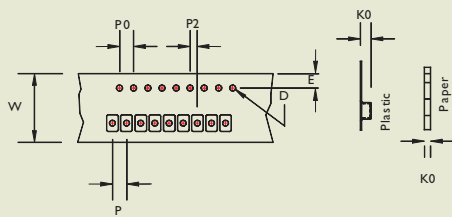

Tape Material

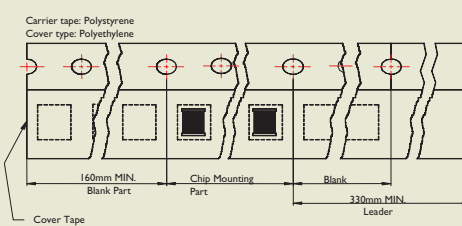

Reel Dimensions

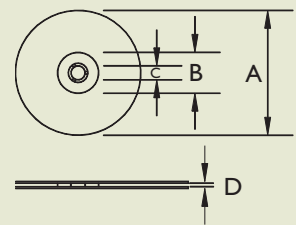

TYPE	TAPE DIMENSIONS							REEL DIMENSIONS				QUANTITY
	K0	D	E	W	P	P0	P2	A	B	C	D	PCS/REEL
SLFI055	6.5	1.55	1.75	24	24	4	2	330	100	13	24.4	500

RECOMMEND SOLDERING CONDITIONS

for: CL/ CLH/ SQV/ SMD power inductors/ SMD Chip Beads/ SMD Filters, Transformers, Current Sensors

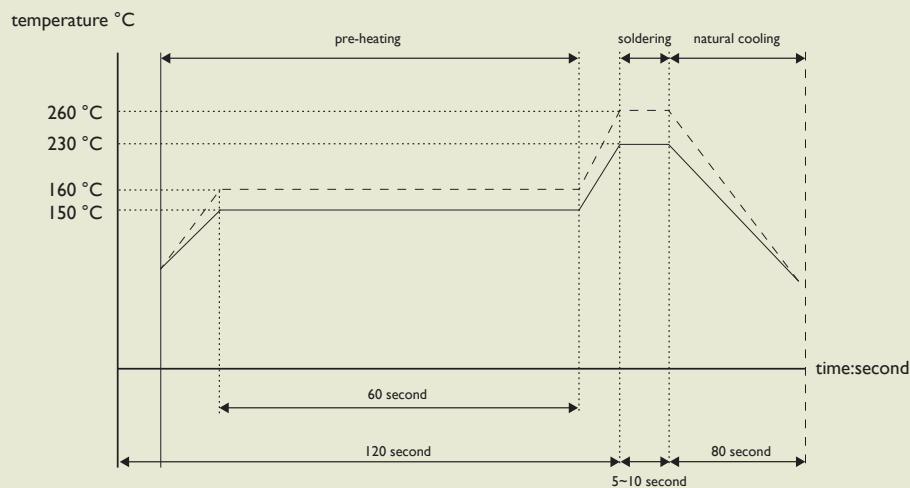

for: lead solder ———
for: lead-free solder ······