

Data Line EMI Filter

SBCB Series

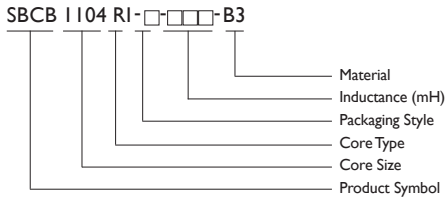

PRODUCT IDENTIFICATION



- Packaging: T: Tape and Reel
- NOTE: YAGEO will add "-N" after original P/N as identification. EX.SBCBI104RIT-330-B3-N

SHAPES AND DIMENSIONS

Dimensions : mm

- Red
- Yellow

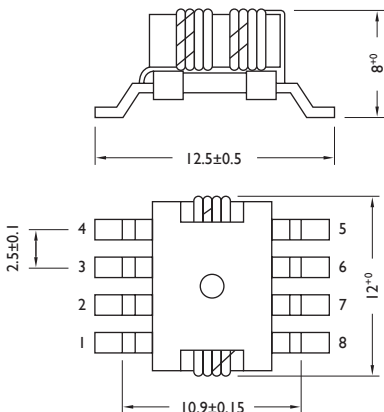

APPLICATIONS

Attenuating Noise of Analog and Digital Signals for Telecommunication Devices

Prevention of Interference from Amateur Radios, CB Stations, or High Frequency Welders, etc.

OUTLINE

These surface mount filters are specially designed to virtually eliminate the problem of conducted EMI in data line applications.They provide both differential and common mode noise attenuation.

These components contain tremendous electrode straight, solder heat resistance and outstanding solderability.These products are designed for flow, reflow and wave soldering required for surface mounting applications.

FEATURES

These components are compatible with auto insertion equipment and easy installed for PC board.

With Four Lines for Voice and Data Line

Compact and High Performance

ELECTRIAL CHARACTERISTICS

PART NO.	INDUCTANCE (μH)	TEST FREQUENCY (KHz) 0.6V	DC RESISTANCE (Ω) Max.
SBCBI104RIT-330-B3	25 ~ 50	100	0.07



TAPE DIMENSIONS

Dimensions : mm

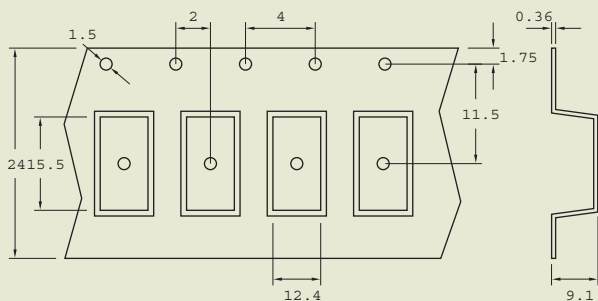

TAPE MATERIAL

Carrier Tape : Black Conductive Polystyrene - Alloy
 Cover Type : Black Conductive Polystyrene - Alloy

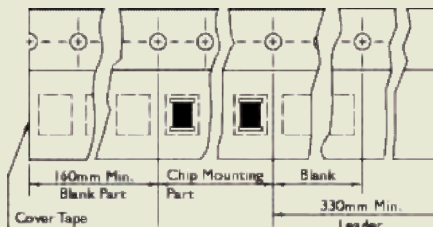

REEL DIMENSIONS

Dimensions : mm

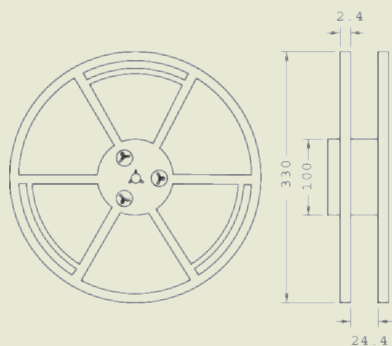

RECOMMENDED PATTERN

Dimensions : mm

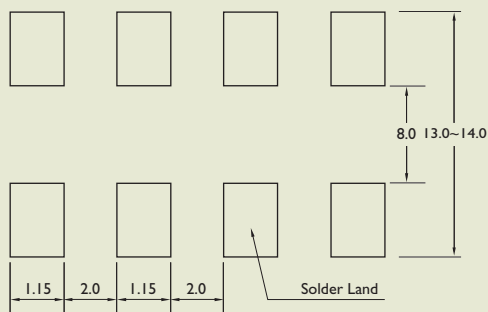

PACKAGING QUANTITY

TYPE	QUANTITY/REEL
SBCBI104	350

TYPICAL ELECTRICAL CHARACTERISTICS

Test Instruments : HP4192A LF Impedance Analyzer

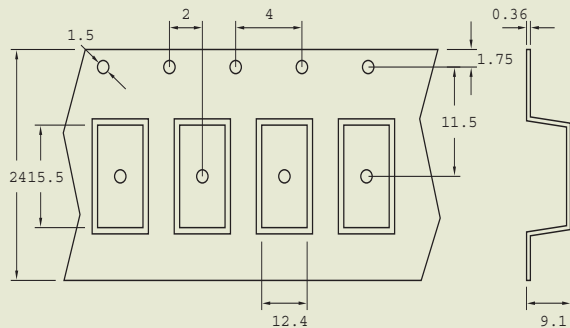



SBCBI 104 SERIES RELIABILITY TEST

I-1 MECHANICAL PERFORMANCE

NO.	ITEM	SPECIFICATION	TEST CONDITIONS
I-1-1	Vibration	Appearance : No Damage L Change : within $\pm 10\%$ Q Change : within $\pm 30\%$ RDC : within Specification	Test device shall be soldered on the substrate. Oscillation Frequency : 10 to 55 to 10Hz for 1Min. Amplitude : 1.5mm Time : 2Hrs. for each Axis (X,Y & Z), Total 6Hrs.
I-1-2	Resistance to Soldering Heat	Appearance : No Damage	Pre-heating : 150°C, 1Min. Solder Composition : Sn/Pb = 63/37 Solder Temperature : 260 \pm 5°C Immersion Time : 10 \pm 1Sec.
I-1-3	Solderability	The electrodes shall be at least 90% covered with new solder coating.	Pre-heating : 150°C, 1Min. Solder Composition : Sn/Pb = 63/37 Solder Temperature : 230 \pm 5°C Immersion Time : 4 \pm 1Sec.

I-2 ENVIRONMENTAL PERFORMANCE

NO.	ITEM	SPECIFICATION	TEST CONDITIONS															
I-2-1	Temperature Shock	Appearance : No Damage L Change : within $\pm 10\%$ L Change : within $\pm 30\%$ RDC : within Specification	10 Cycles (Air to Air) 1 Cycles shall Consist of : 30Min. Exposure to -55°C 30Min. Exposure to 125°C 15Sec. Max. Transition between Temperatures Measured after Exposure in the Room Condition for 24Hrs.															
I-2-2	Temperature Cycle		One Cycle <table border="1"> <thead> <tr> <th>Step</th> <th>Temperature (°C)</th> <th>Time (Min.)</th> </tr> </thead> <tbody> <tr> <td>1</td> <td>-25 \pm 3</td> <td>30</td> </tr> <tr> <td>2</td> <td>25 \pm 2</td> <td>3</td> </tr> <tr> <td>3</td> <td>85 \pm 3</td> <td>30</td> </tr> <tr> <td>4</td> <td>25 \pm 2</td> <td>3</td> </tr> </tbody> </table> Total : 100 Cycles Measured after Exposure in the Room Condition for 24Hrs.	Step	Temperature (°C)	Time (Min.)	1	-25 \pm 3	30	2	25 \pm 2	3	3	85 \pm 3	30	4	25 \pm 2	3
Step	Temperature (°C)	Time (Min.)																
1	-25 \pm 3	30																
2	25 \pm 2	3																
3	85 \pm 3	30																
4	25 \pm 2	3																
I-2-3	Humidity Resistance		Temperature : 40 \pm 2°C Relative Humidity : 90 ~ 95% Time : 1000Hrs. Measured after Exposure in the Room Condition for 24Hrs.															
I-2-4	High Temperature Resistance		Temperature : 85 \pm 3°C Relative Humidity : 20% Applied Current : Rated Current Time : 1000Hrs. Measured after Exposure in the Room Condition for 24Hrs.															
I-2-5	Low Temperature Resistance		Temperature : -25 \pm 3°C Relative Humidity : 0% Time : 1000Hrs. Measured after Exposure in the Room Condition for 24Hrs.															

SBCB Series

EMC Common Mode Filter

SBCB Series is a dual wound common mode choke ideal for common mode noise attenuation in twisted pair cable interfaces as well as IEEE 1394 applications. An excellent impedance balance between two sets of twisted pairs is achieved by winding across a signal core. One SBCB common mode choke coil per interface port is possible with this dual winding configuration.

APPLICATIONS

- Preventive measure against USB & IEEE1394 radiation emissions.
- Suppresses radiated emissions from peripheral devices.
- Personal computer (Desk-top, Note-book) game computer, Digital Camera, etc.
- Use of high performance ferrite for excellent high frequency characteristics.

FEATURES

- Dual Common-mode choke coils.
- 8-pin, half inch-pitch SMD type

SHAPES AND DIMENSIONS

TYPE	DIMENSION
SBCB656030-S	

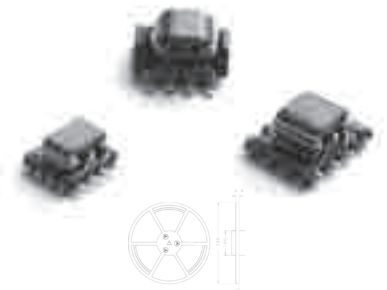

PRODUCT IDENTIFICATION

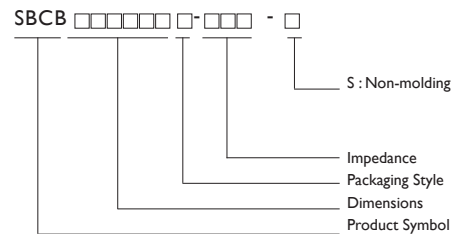

- Packaging: T: Tape and Reel
- NOTE: YAGEO will start to release lead-free that meet SONY SS-00259's criteria
YAGEO will add "-N" after original P/N as identification. EX. SBCB656030T-900-S -N



PACKAGING

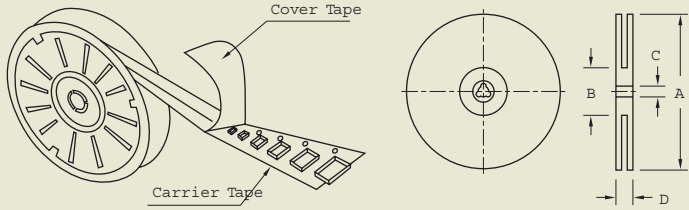

SBCB656030-S

Pcs/Reel	1000
A	330mm
B	100mm
C	13.0mm
D	21.0mm

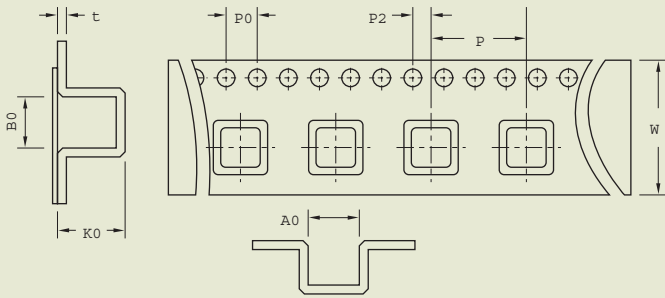

SBCB656030-S

A0	6.6
B0	6.15
K0	3.5
P	12
P0	4.0
P2	2.0
W	16.0
t	0.35

RECOMMENDED PATTERN

Recommended Pattern

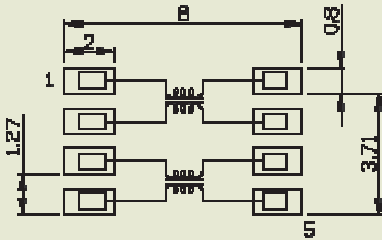

Twisted Pair Cable interface

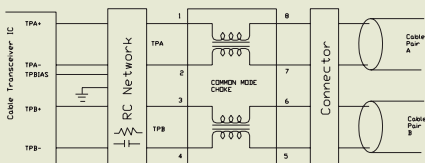

IEEE 1394 Port

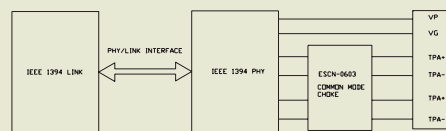



ELECTRICAL CHARACTERISTICS

Model no.	Rated Current (ma) Max.	DC Resistance (Ω /Line)Max.	Withstand Voltage
SBCB656030T - □□□ - □	500	0.12	80V DC

ELECTRICAL CHARACTERISTICS

Part Number	Impedance(Ω) Common Mode		Impedance(Ω) Normal Mode	
	@10Mhz(Ω)Min	@100Mhz(Ω)Min	@10Mhz(Ω)Min	@100Mhz(Ω)Min
SBCB656030T-900-S	9	60	2	9
SBCB656030T-181-S	15	150	3	16
SBCB656030T-301-S	20	200	3	20
SBCB656030T-601-S	25	480	3	15

SBCB656030T-301-S

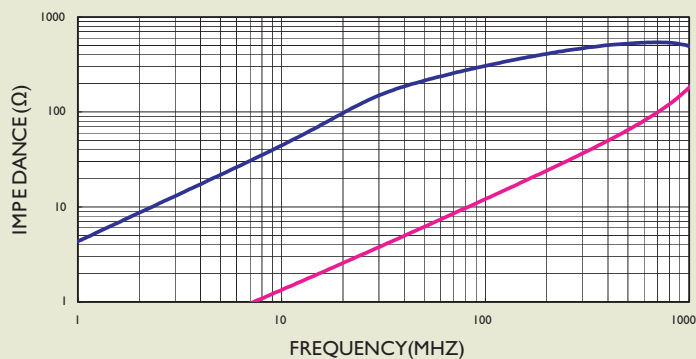

SBCB656030T-601-S

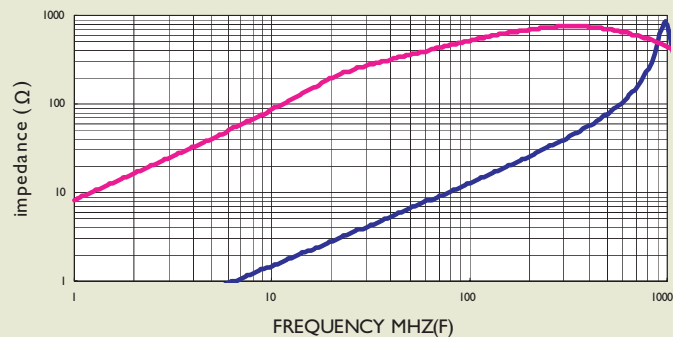

SBCB656030T-181-S

